

Since 1968

COMMAX
SmartHome & Security

User Manual

Doorphone AP-3SG



www.commax.com

COMMAX Co.,Ltd.



- Thank you for purchasing COMMAX products.
- Please carefully read this User's Guide (in particular, precautions for safety) before using a product and follow instructions to use a product exactly.
- The company is not responsible for any safety accidents caused by abnormal operation of the product.



Contents

| | |
|-------------------------------|---|
| 1. Greetings | 1 |
| 2. Warnings and caution | 2 |
| 3. Part names | 4 |
| 4. Features & Functions | 4 |
| 5. Contents | 5 |
| 6. Wiring | 5 |
| 7. Installation | 6 |
| 8. Operating | 7 |
| 9. Trouble shooting | 8 |
| 10. Specification | 8 |











1. Greetings

- * Thank you very much for purchasing of COMMAX products.
- * Please read carefully this user manual and follow its rules.
- * This intercom can be used in offices, and shopping outlets, and provide convenience to use communication on long distances.













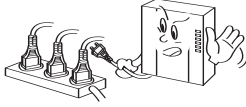

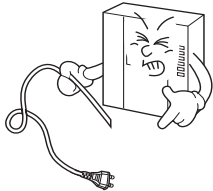



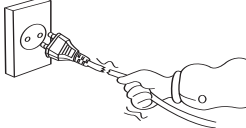

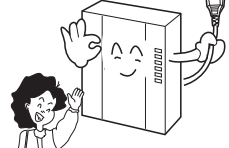

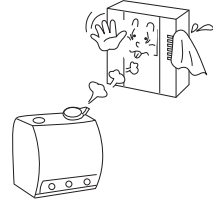

2. Warnings and caution

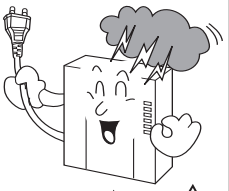
Please follow the things described below in order to prevent any danger or property damage.

| | | |
|---|--|--|
|  | <p>Warning It may cause a serious damage or injury if violated.</p> |  Prohibition.  No disassembly  No touch  Must follow strictly.  Shows plugging out the power cord without an exception  Shows the warning and caution for an electric shock.  Shows the warning and caution for a fire. |
|  | <p>Caution It may cause a minor damage or injury if violated.</p> | |

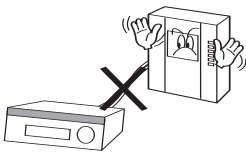
! Warning

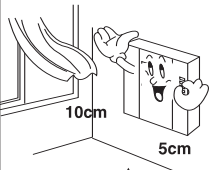
Power & Installation

| | | | |
|--|--|--|---|
| <p>Please don't use several products at the same time on one power socket. · It may cause a fire due to an abnormal overheating.</p>  <p style="text-align: center;">   </p> <p style="text-align: center;">Prohibition Fire</p> | <p>Please don't bend the power cable excessively or it may cause an electric shock. · fire when using a damaged power cable.</p>  <p style="text-align: center;">    </p> <p style="text-align: center;">Prohibition Electric shock Fire</p> | <p>Please don't handle the power cable with a wet hand. · It may cause an electric shock.</p>  <p style="text-align: center;">   </p> <p style="text-align: center;">Prohibition Fire</p> | <p>Please plug out the power cable from the socket when not using it for a long period of time. · It may shorten the product lifespan or cause a fire.</p>  <p style="text-align: center;">   </p> <p style="text-align: center;">Request Fire</p> |
| <p>Please don't install the product in the place where there is much oil, smoke or humidity. · It may cause an electric shock or fire.</p>  <p style="text-align: center;">    </p> <p style="text-align: center;">Prohibition Electric shock Fire</p> | <p>Please don't install the product with the lightning and thunder. · It may cause an electric shock or fire.</p>  <p style="text-align: center;">    </p> <p style="text-align: center;">Prohibition Electric shock Fire</p> | <p>Please don't use and connect this product with other products with different rated voltage. · It may cause a disorder or fire.</p>  <p style="text-align: center;">   </p> <p style="text-align: center;">Prohibition Fire</p> | <p>When installing the product that generates heat, please install the product away from the wall (10cm) for the ventilation. · It may cause a fire due to the increased internal temperature.</p>  <p style="text-align: center;">   </p> <p style="text-align: center;">Prohibition Fire</p> |

⚠ Warning

Cleaning & Use

Please don't disassemble, repair or rebuild this product arbitrarily (please contact the service center if a repair is needed).

- It may cause an electric shock or fire.

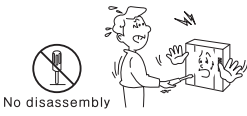

If an abnormal sound, burning smell or smoke is coming out of the product, please plug out the power cable and contact a service center.

- It may cause an electric shock or fire.

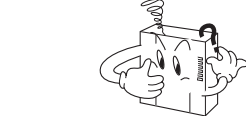

Please don't insert any metallic or burnable materials into the ventilation hole.

- It may cause an electric shock or fire.

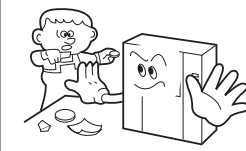

Please use only the designated batteries for the products of using DC power.

- It may cause an electric shock or fire.



⚠ Caution

Power & Installation

Please plug the power cable firmly into the inner end

- It may cause a fire.

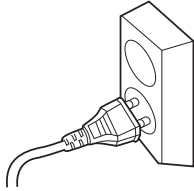

Please hold the plug tightly when unplugging the power cable (a part of the copper wire may be disconnected if the grabbing is only made on the cord when pulling out the cable).

- It may cause an electric shock or fire



When connecting the power cables after cutting the cable, please install the product with power off

- It may cause an electric shock or fire



When installing the product, please fix it firmly while using the wall-mounting unit and screws.

- It may cause an injury from the falling object.

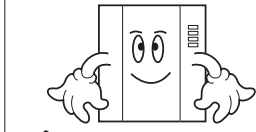

Please be careful when using an AC circuit breaker since there is a possibility of an electric shock.

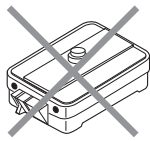

Please check the use voltage and current for the DC-only products and use the appropriate rectifier.

- It may cause a fire.

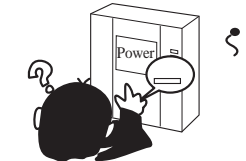

Please avoid direct rays of the sun or heating devices at a time of installation.

- It may cause a fire.

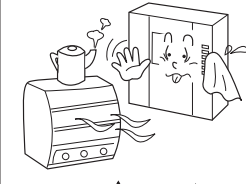

Please don't install the product on an unstable place or small support board.

- It may cause an injury if it falls down while in use.

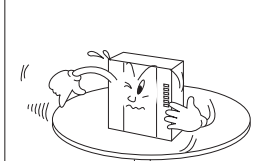

Cleaning & Use

When cleaning the product, please rub it with a soft and dry cloth after plugging out the power cable. (Please don't use any chemical products such as wax, benzene, alcohol or cleanser.)

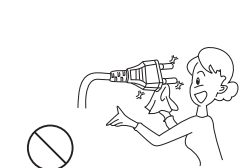

Please don't drop the product on the ground and don't apply a shock.

- It may cause a failure.

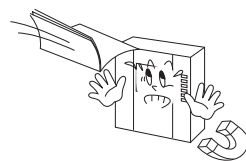

Please use the designated connection cable within the maximum calling distance designated for the product

- It may reduce the product performance.



3. Part names

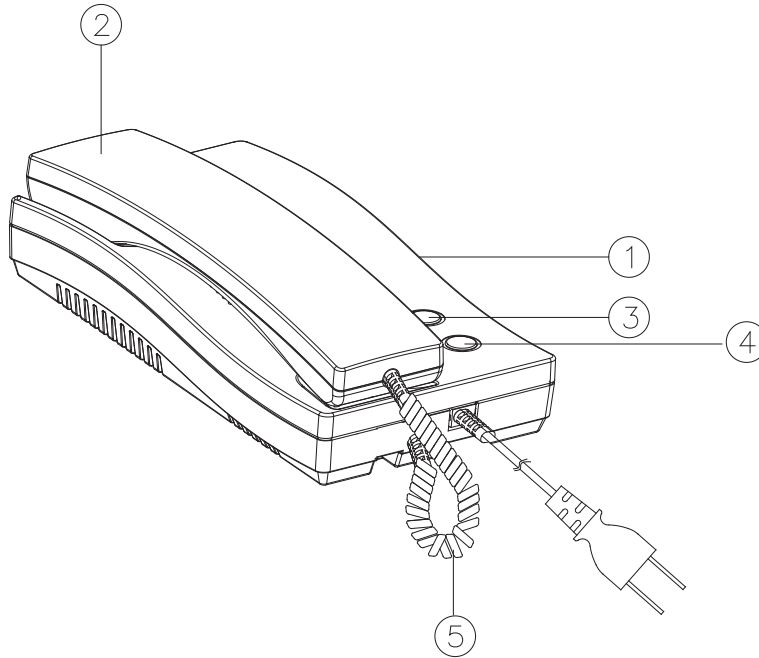

| No. | Name | Description |
|-----|--------------------|---------------------------------|
| 1 | Call Volume switch | The part to control call volume |
| 2 | Handset | |
| 3 | Guard button | To call guardian |
| 4 | Door open button | |
| 5 | S • code | |

4. Functions

- * Calling to Guard unit and talking
- * Door release (Interlocking with Door phone)
- * Talking to Common lobby and Individual front door

5. Contents

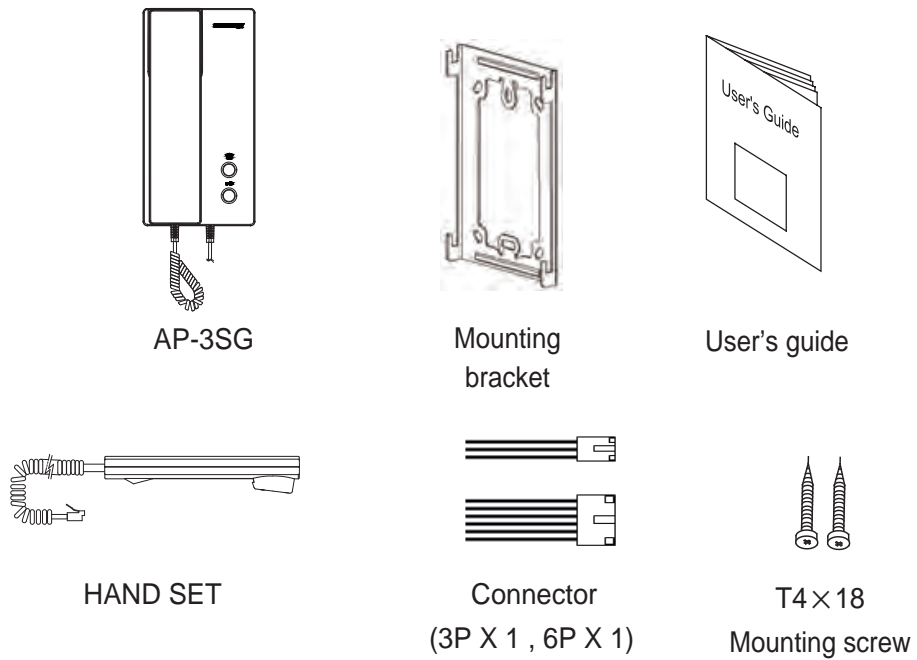

6. Wiring

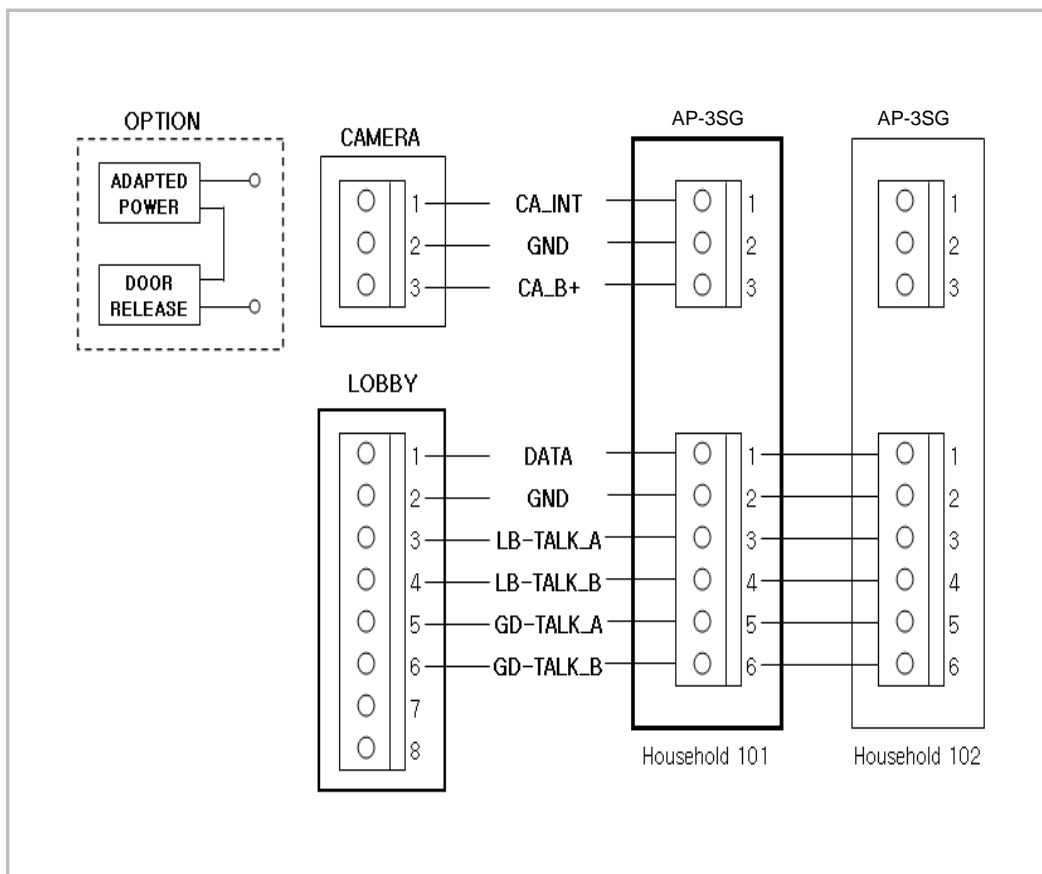

7. Installation

1. AP-3SG

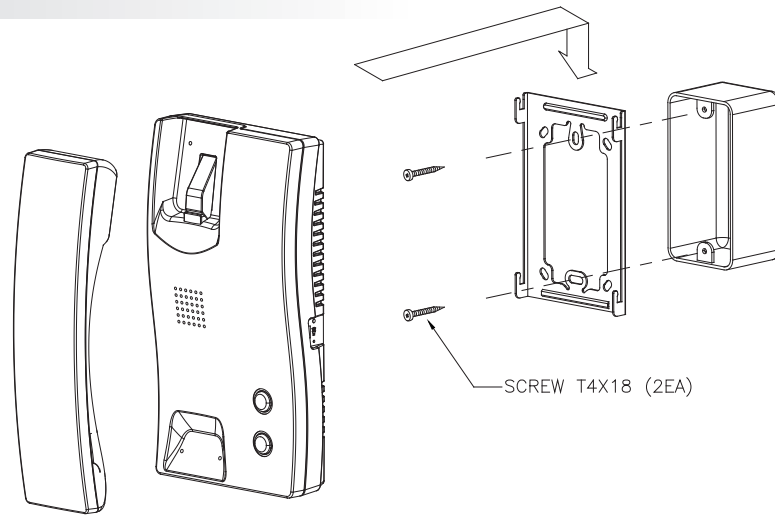

* Caution for Monitor

When to install it, avoid the place where can be influenced by Magnetism, Humidity, Direct light and heater.

2. Audio Door Station

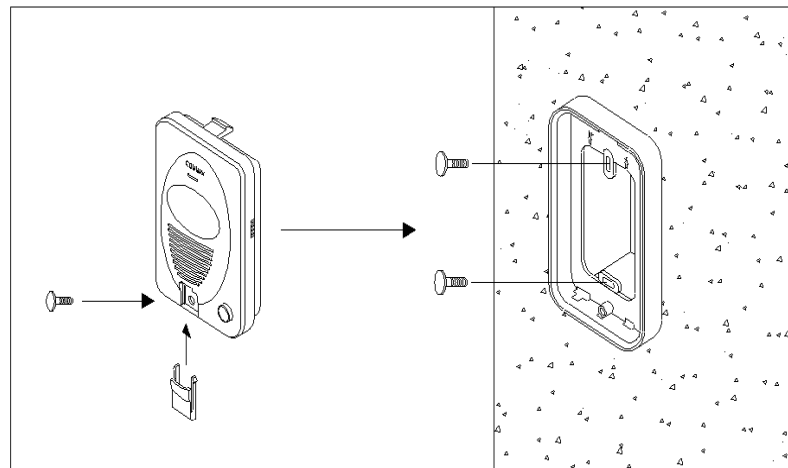



8. Operating

1) Calling of Visitor

- ① When a visitor presses call button, with Calling sound from the speaker is emitted.
- ② For Visitors, please talk with the handset (Currency time 60 second)
- ③ When lay the handset after the end of taking with a visitor, everything is done. When a visitor is allowed to be in, the door is released with the sound, if a user presses the door open button,
(In case of using the camera which is interlocked with Door released function)
- ④ If guard or lobby calls during the coversation between house and individual entrance, phone rings. If you hang up the phone and pick it up again at this time, it will switch the phone over to guard or lobby. (Previous call is ended)
Caution : Do not hold the handset at your ear when you press hook switch to switch call.

2) Calling with Common lobby

- ① Calling sound from the speaker is emitted when a visitor calls from Common lobby.
Pick the handset to talk this time
- ② The sound of Door station is emitted while talking over the phone with the Common lobby.
- ③ If you hang up the phone and pick it up again, the coversation with Lobby will be disconnected, and the coversation with individual entracne will be available. If the door release button is pressed while talking over the phone with Common lobby, the door is released with sound and the talk is ended.
Caution: Do not hold the handset at your ear when you press hook switch to switch call.

3) Calling with Guard station

- ① Pick up the handset which is connected with a Guard station.
and if a user presses the Guard button, the sound will be emitted from Guard station.
The talk between Guard and monitor is available this time.
- ② The calling sound is emitted from the handset if the Call button is pressed while talking over the phone with Guard station, and it is automatically shut down after 30 minutes by showing the screen of outside status
Caution : Do not hold the handset at your ear when you press hook switch to switch call.
- ③ If the call button is pressed from Guard station while talking over the phone with the Door station, the Signal sound is emitted to the handset. And the talk with Guard station is available if a user lays and picks the handset of the monitor or press the Guard button.
Caution : Do not hold the handset at your ear when you press hook switch to switch call.
- ④ When a guardian would like to talk with a household, the calling sound is emitted from the Monitor if the guardian presses the call button. And if a users picks up the handset, the talk is available with a Guardian

9. Trouble shooting.

If you think that the product has trouble, please first check below contents before you ask a repair.

| Troubles | Check Point | Actions |
|--|--|---|
| <ul style="list-style-type: none"> The power supply is not on. All works are stopped | <ol style="list-style-type: none"> The power supply cord is missing or not. The power supply switch (down) is off or not. | <ol style="list-style-type: none"> Please connect the power supply cord Please turn on the power switch pushing the left (down) to the right(up). |
| <ul style="list-style-type: none"> A Call operation is not performed. (Door, Interphone function) | <ol style="list-style-type: none"> The wiring between other units is connected correctly in good order or not. The wiring is missing or not. | <ol style="list-style-type: none"> Please refer to connection related page and manage. Please connect correctly to the terminal. |
| <ul style="list-style-type: none"> The product does not produce the sound. (Call volume, Talk volume) | <ol style="list-style-type: none"> A sound volume lies in minimum or not. | <ol style="list-style-type: none"> Please adjust the sound volume switch properly turing the left(down) to the right(up), as you want. |

10. Specifications

| Contents | Description (AP-3SG) |
|-------------------|---|
| Wiring | Common Lobby : 6 wires, Door camera : 4 wires |
| Rated Voltage | 220~230V~, 50/60Hz |
| Power consumption | Stan-by mode : 3W Operating : (Max.) 4W |
| Distance | Door : 50m/ \varnothing 0.65, Common lobby : 300m (UTP) |
| Temperature | 0°C ~ +40°C |
| Dimension | 107(W) X 195(H) X 38(D) mm |
| Weight | 600g |

COMMAX

COMMAX Co.,Ltd.

513-11, Sangdaewon-dong, Jungwon-gu, Seongnam-si, Gyeonggi-do, Korea

Int'l Business Dept. Tel. : +82-31-7393-540~550 Fax. : +82-31-745-2133

Web site : www.commax.com

Printed In Korea / 2011.11.104